



## INSTALLATION INSTRUCTIONS

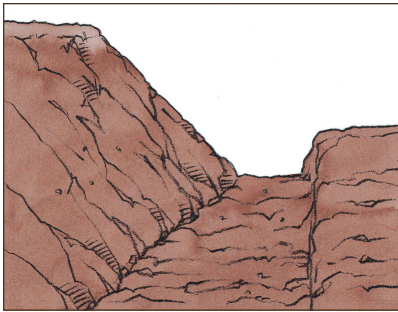

Diagram 1—Excavation

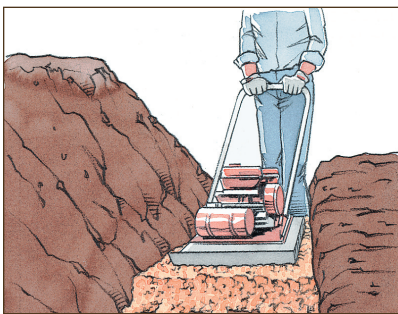

Diagram 2—Leveling Pad

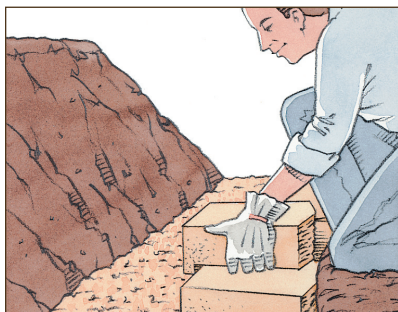

Diagram 3—Next-Course Construction

### 1 STAKE OUT THE WALL

- Have a surveyor stake out the wall's placement. Verify the locations with the project supervisor.

### 2 EXCAVATION

- Excavate for the leveling pad to the lines and grades shown on the approved plans, and excavate enough soil from behind the wall for the geosynthetic reinforcement material.
- The trench for the leveling pad should be at least 2 feet wide and 1 foot deep.

See *Diagram 1*.

### 3 LEVELING PAD

- An aggregate leveling pad is made of compactible base material of  $\frac{3}{4}$ -inch minus with fines.
- The pad must extend 6 inches in front and behind the first course of block, and be at least 6 inches deep after compaction.
- Compact the aggregate and make sure it's level. See *Diagram 2*.

### 4 BASE COURSE

- This is the most important step in the installation process.
- Begin laying block at the lowest elevation of the wall whenever possible.
- Remove the rear lip of the block by hitting with a hammer and chisel from the back so that the block will lie flat on the leveling pad.
- Place first block and level, front to back and side to side; lay subsequent blocks in same manner.
- Place the blocks side by side, flush against each other, and make sure the blocks are in full contact with the leveling pad. Level front to back and side to side.
- Place soil in front of the base course and compact. Base course should be buried. Continue to fill and compact after each course is laid.
- If the wall is on an incline, don't slope the blocks. Step them up so they remain consistently level.
- Use string along back edge of the block to check for proper alignment.

### 5 CONSTRUCTION OF THE NEXT COURSE

- Fill voids between blocks with  $\frac{3}{4}$ -inch clean drainage aggregate prior to laying the next course of block. Clean any debris off the top of the blocks.
- Place the second course of blocks on top of the base course. Maintain running bond. Pull each block forward as far as possible to ensure the correct setback. See *Diagram 3*.
- Backfill with drainage aggregate directly behind the block, adding 6 to 8 inches at a time. Add soil fill behind the aggregate.
- Compact before the next course is laid. Don't drive heavy equipment near the wall. Self-propelled compaction equipment should not be used within 4 feet of the face of the wall.
- You'll need partial units to stay on bond. A circular saw with a masonry blade is recommended for cutting partial units. Use safety glasses and other protective equipment when cutting.

### 6 DRAINAGE DESIGN

- Each project is unique. The grades on your site will determine at what level to install the drainpipe.
- Place the drainpipe (4-inch perforated piping) so water drains down and away from the wall into a storm drain, or daylight just above grade. See *Diagram 5*.
- Fill in the area behind the blocks with clean drainage aggregate, at least 1 foot from the wall.
- You may need to place and backfill several courses to achieve the proper drainage level.
- The outlet pipes should be spaced not more than every 50 feet and at low points of the wall. In order for the drainage aggregate to function properly, it must keep clear of regular soil fill. See *Diagram 5 and 6*.

### 7 COMPACTION

- Shovel the backfill soil behind the drainage aggregate and compact the backfill with a hand-operated compactor.
- Make sure the aggregate is level with or slightly below the top of the base course.
- Base course should be buried. Continue to fill and compact after each course is laid.

## INSTALLATION INSTRUCTIONS

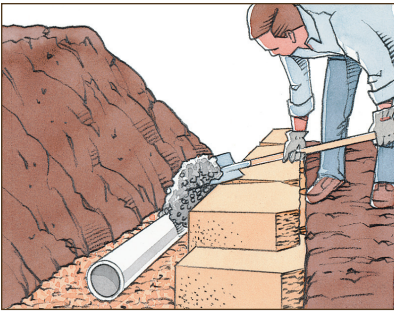

Diagram 6—Drainage

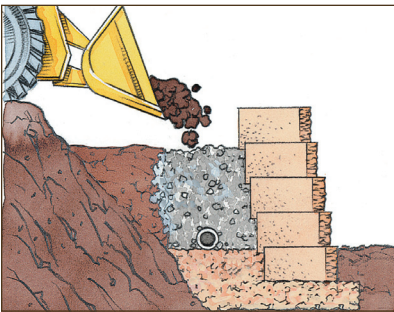

Diagram 7—Backfill

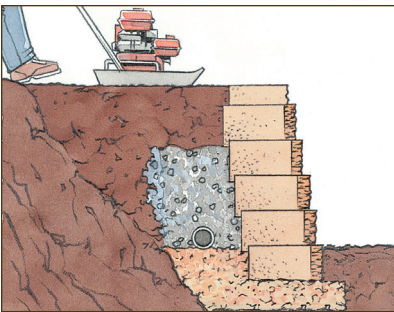

Diagram 8—Compaction

### 8 REINFORCEMENT (IF REQUIRED)

- Geosynthetic reinforcement is recommended for walls taller than 4 feet 6 inches, or walls situated in poor soils, supporting a driveway, etc. Consult an engineer for design assistance.
- Check the wall construction plan for which courses will need reinforcement.
- Clean any debris off the top layer of blocks.
- Measure and cut the reinforcement to the design length in the plans.
- The reinforcement has a design strength direction, which must be laid perpendicular to the wall.
- Place the front edge of the material on the top course, 1 inch from the face of the block.
- Apply the next course of blocks to secure reinforcement material in place.
- To keep it from wrinkling, pull the reinforcement taut and pin the back edge in place with stakes or staples.
- Add drainage aggregate behind the blocks; then add the soil and compact it. It is ideal to fill from the wall toward the cut. See *Diagram 6*.
- A minimum of 6 inches of backfill is required to provide cushioning prior to operating vehicles on the reinforcement. Avoid sudden turning or braking when operating vehicles on the reinforcement area. See *Diagram 6*.

### 9 CAPPING A WALL

#### Straight wall

- Caps are trapezoidal and must be laid alternating short and long cap faces for a straight line. Always start capping from the lowest elevation.

#### Outside curves

- Lay cap units side by side and cut at least every other cap to produce a uniform look. Start with the long side of the cap facing out and adjust to the radius.

#### Inside curves

- Lay cap units side by side with the short side facing out. In most circumstances, making two cuts on one cap and then not cutting the adjacent caps produces the most pleasing look.

#### Corners

- On a 90-degree corner wall, the corner caps need to be saw-cut to achieve a 45-degree mitered corner.

#### Stepping up caps

- If a wall elevation changes, caps can be stacked where the wall steps up. Begin laying caps at the lowest elevation change and work your way toward the previous step up. Split a cap unit to create a rough face on the exposed side. Place the partial cap unit directly on top of the capped portion of the wall with all three split faces exposed.

#### Finishing

- After layout is complete and caps are saw-cut or split to size, carefully glue in place with a concrete adhesive.

### 10 FINISH GRADE AND SURFACE DRAINAGE

- Protect the wall with a finished grade at the top and bottom.
- To ensure proper water drainage away from the wall, use 6 inches of soil with low permeability. This will minimize water seeping into the soil and drainage aggregate behind the wall.

### 11 SITE CLEANING AND RESTORATION

- Brush off the wall and pick up any debris left from the construction process.
- Notify the job superintendent in writing of the completion and that it is ready for final inspection and acceptance.
- Planting vegetation in front and on top of the wall will help reduce the chance of erosion.

**SAFETY NOTE:** Always use appropriate equipment, including safety glasses or goggles and respirators, when splitting, cutting or hammering units.



FEATURING MULTIPIECE RETAINING AND FREESTANDING WALL SYSTEMS



# Installation Guide

# Table of Contents and How to Use This Guide

## TABLE OF CONTENTS

HOW TO USE THIS GUIDE . . . . .	2
BEFORE YOU BEGIN . . . . .	2
RETAINING WALL BASICS . . . . .	3
RETAINING WALL INSTALLATION INSTRUCTIONS	
Best Practices . . . . .	4
Wall Patterns for Multipiece Retaining Wall Systems . . . . .	6
Capping a Wall . . . . .	7
Stepping Up the Base . . . . .	8
Abutting an Existing Structure . . . . .	8
Capping a Column . . . . .	8
Daylighting Drainage . . . . .	9
Drainage Swales . . . . .	9
Steps in a 90° Wall . . . . .	10
Steps in a Curved Wall . . . . .	11
Outside Curves . . . . .	12
Outside Curves with Geosynthetic Reinforcement . . . . .	13
Inside Curves . . . . .	14
Inside Curves with Geosynthetic Reinforcement . . . . .	14
Outside 90° Corners . . . . .	15
Outside 90° Corners with Geosynthetic Reinforcement . . . . .	15
Inside 90° Corners . . . . .	16
Inside 90° Corners with Geosynthetic Reinforcement . . . . .	17
Water Applications . . . . .	18
Terraces . . . . .	19
Fences . . . . .	19
FREESTANDING WALL	
Installation Instructions . . . . .	20
Construction Details . . . . .	22

## HOW TO USE THIS GUIDE

This guide is designed to provide you with ideas as well as information on product use and installation procedures. Because actual project conditions vary, final wall design, including the incorporation of geosynthetic reinforcement, must be performed by a qualified engineer. While this guide provides general guidelines, installation contractors should refer to construction drawings provided by a qualified local engineer for final specifications.

Additional installation information is available online at [anchorwall.com](http://anchorwall.com). Information includes basic wall construction and installation videos.

## BEFORE YOU BEGIN

Advance planning and careful layout at the job site help ensure a successful retaining and freestanding wall project.

- Review the site plan to confirm lot lines, wall location, length and elevations.
- Understand on-site soils. Ideal soils are sand and gravel. For walls built in clay or poor soils, work with a local engineer to confirm the wall design and the required soil reinforcement. Black or organic soils should not be used as backfill.
- Confirm the location of underground utilities.
- Seek all necessary building permits.
- Prepare a drawing of the site with the wall location, lengths and elevations.
- Plan drainage to prevent erosion or buildup of water behind the wall. Consider where the water will drain through the wall, where downspouts will expel and whether there's an underground sprinkler. For walls greater than 3 feet in height, a perforated drainpipe is recommended at the base of the aggregate to quickly remove large amounts of water. See page 9 for more information on water management.
- Check the block delivered to ensure it is the correct color. Check the geogrid to confirm that it's the strength and weight specified in the engineering plans.
- Be sure to use the right tools. Hand tools include a shovel, 4-foot level, dead-blow hammer, 2- or 3-pound hammer, chisel, hand tamper, hydraulic splitter and string line. Power tools include a circular saw with a masonry blade and a compactor.
- Always wear protective eyewear.

Segmental retaining walls typically fall into one of three categories.

## GRAVITY RETAINING WALL

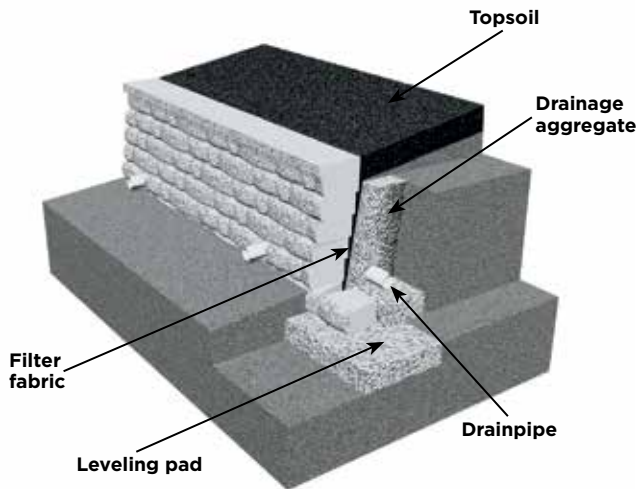

The first category - a gravity wall - is a retaining wall that does not use soil reinforcement. A gravity wall has height limitations specific to each product. An advantage of this type of retaining wall is that it requires a smaller work area behind the wall. A gravity wall relies on the weight and setback of the block to resist the soil forces being exerted on the wall.

## GEOSYNTHETIC-REINFORCED RETAINING WALL

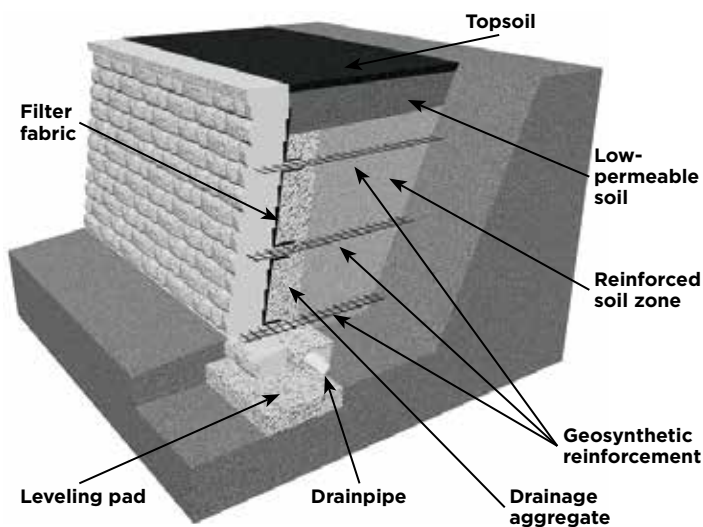

The second category is a geosynthetic-reinforced wall, which needs to be designed by a qualified engineer. There are (theoretically) no height limitations with reinforced retaining walls, and they are used in larger applications. They require more work area behind the structure. The block of soil is stabilized by introducing reinforcement layers into the soil mass behind the facing units. The larger the stabilized soil mass, the more soil can be retained or held back. The geogrid in the soil extends past the theoretical failure plane and serves to create a large, rectangular mass of block and soil, restraining the retained soil.

## ANCHORPLEX™ SYSTEM

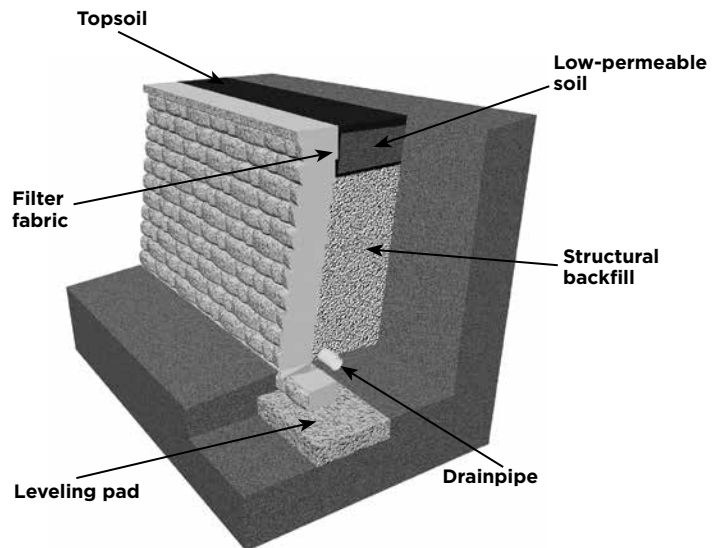

The third category is the Anchorplex™ system, which offers a unique, nonconventional solution to problematic wall construction sites. It is a retaining wall built with Anchor™ products and structural backfill specified by Anchor Wall Systems, and backed by engineering support tools developed by Anchor.

Use of the Anchorplex system completely eliminates the need for the construction of a mechanically stabilized earth zone behind the wall facing and requires substantially less excavation than is usually necessary in geosynthetic-reinforced wall construction.

For more information about the Anchorplex system, go to [anchorwall.com](http://anchorwall.com).

# Retaining Wall Installation—Best Practices

## STAKE OUT THE WALL

- Have a surveyor stake out the wall's placement. Verify the locations with the project supervisor.

## EXCAVATION

- Excavate for the leveling pad to the lines and grades shown on the approved plans and excavate enough soil behind the wall for the geosynthetic reinforcement material, if needed.
- The trench for the leveling pad should be at least 12 inches wider than the block you are installing and 6 inches deeper than the height of the block. See *Diagram 1*.

## LEVELING PAD

- An aggregate leveling pad is made of compactable base material of  $\frac{3}{4}$ -inch minus (with fines).
- The pad must extend at least 6 inches in front of and behind the first course of block and be at least 6 inches deep after compaction.
- If the planned grade along the wall front will change elevation, the leveling pad may be stepped up in 6-inch increments to match the grade change. Start at the lowest level and work upward whenever possible.
- Compact the aggregate and make sure it's level front to back and side to side. Mist lightly with water before compaction. See *Diagram 2*.

## BASE COURSE

- This is the most important step in the installation process. Bury the base course of block.
- Begin laying block at the lowest elevation of the wall. Remove the rear lip of the block by hitting from the back so that it will lie flat on the leveling pad.
- Place the first block level, front to back and side to side; lay subsequent blocks in the same manner.
- Place the blocks side by side, flush against each other, and make sure they are in full contact with the leveling pad.
- If the wall is on an incline, don't slope the blocks; step them up so they remain consistently level. (See page 7 for more information.)
- Use string line along the back edge of block to check for proper alignment.
- For multipiece products, use the largest unit, 18 inches wide, for the base course.
- Fill cores (if applicable) and voids between blocks with  $\frac{3}{4}$ -inch free-draining aggregate prior to laying the next course of block. Clean any debris off the top of the blocks.  
*The Torpedo® base block is an option for walls up to maximum gravity height.*

## CONSTRUCTION OF SUBSEQUENT COURSES

- Clean any debris off the top of the blocks.
- You can install these products using any combination of blocks.
- Place the second course of blocks on top of the base course. Maintain running bond. Pull each block forward as far as possible to ensure the correct setback. See *Diagram 3*.
- Fill cores (if applicable) and voids between blocks with  $\frac{3}{4}$ -inch free-draining aggregate prior to laying the next course of block. Clean any debris off the top of the blocks.
- For best results, use a filter fabric, which should be placed directly behind the wall extending from the bottom of the base course to the middle of the top course. This will minimize material coming through the rough-hewn face texture of these products. We recommend a non-woven, 4- to 6-ounce fabric. See *Diagram 4*.
- Backfill with  $\frac{3}{4}$ -inch free-draining aggregate directly behind the block, adding 6 inches at a time followed by proper compaction.
- Add soil fill behind the aggregate. Compact before the next course is laid.
- Don't drive heavy equipment near the wall. Self-propelled compaction equipment should not be used within 4 feet of the wall.
- You may need partial units to stay on bond. A circular saw with a masonry blade is recommended for cutting partial units. Use safety glasses and other protective equipment when cutting.
- Keep the wall bond by placing units in a staggered relationship to the course beneath.

The following installation instructions apply to Anchor retaining wall products that feature a rear lip. Where there are variations, the appropriate information has been noted.

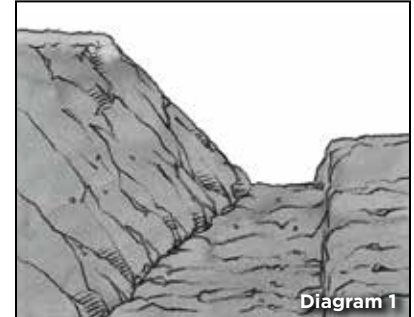

Excavation

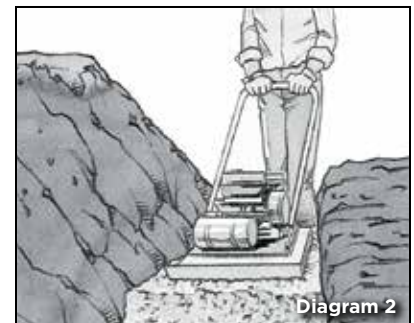

Leveling pad compaction



Construction of the next course

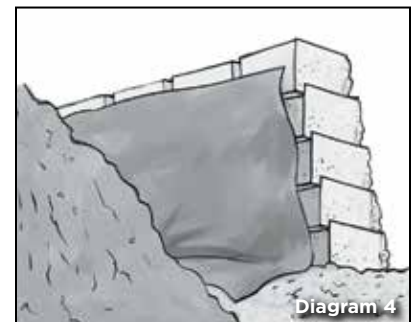

Filter fabric

## CAPPING

See page 8 for more information about cap installation.

## DRAINAGE DESIGN

- Each project is unique. The grades on your site will determine at what level to install the drainpipe.
- Place the drainpipe as low as possible behind the wall so water drains down and away from the wall into a storm drain or to an area lower than the wall. See *Diagram 5*.
- Fill in the area behind the blocks with  $\frac{3}{4}$ -inch free-draining aggregate, at least 12 inches from the wall.
- You may need to place and backfill several courses to achieve the proper drainage level.
- Cover the drainpipe with a geotextile sock which acts as a filter. The drainpipe outlets should be spaced not more than every 50 feet and at low points of the wall. In order for the drainage aggregate to function properly, it must keep clear of regular soil fill. (See page 9 for more information.)

## COMPACTION

- Place the backfill soil behind the drainage aggregate and compact with a hand-operated compactor.
- Make sure the aggregate is level with or slightly below the top of the base course.
- Place soil in front of the base course and compact. The base course should be buried.
- Continue to fill and compact. See *Diagram 7*.

## GEOSYNTHETIC REINFORCEMENT (IF REQUIRED)

- Geosynthetic reinforcement is recommended for walls taller than gravity height walls situated in poor soils, supporting a driveway, etc. Consult a qualified engineer for design assistance.
- Check the wall construction plan for which courses will need geogrid.
- Clean any debris off the top layer of blocks.
- Measure and cut the geogrid to the design length in the plans.
- The geogrid has a design strength direction, which must be laid perpendicular to the wall.
- Place the front edge of the material on the top course, 1 inch from the face of the block.
- Apply the next course of blocks to secure it in place.
- To keep it from wrinkling, pull the geogrid taut and pin the back edge in place with stakes or staples.
- Add drainage aggregate behind the blocks, then add the soil and compact it. See *Diagrams 6 and 7*.
- Place the front edge of the geogrid on top of the block, making sure it's within 1 inch of the face of the block. Correct placement ensures that you maximize the connection strength and keep the batter consistent.
- A minimum of 6 inches of backfill is required prior to operating vehicles on the geosynthetic reinforcement. Avoid sudden turning or braking. See *Diagram 7*.

## FINISH GRADE AND SURFACE DRAINAGE

- Protect the wall with a finished grade at the top and bottom.
- To ensure proper water drainage away from the wall, use 6 inches of soil with low permeability. This will minimize water seeping into the soil and drainage aggregate behind the wall.

## SITE CLEANING AND RESTORATION

- Brush off the wall and pick up any debris left from the construction process.
- Notify the job superintendent in writing of the project's completion and that it is ready for final inspection and acceptance.
- Planting vegetation in front and on top of the wall will help reduce the chance of erosion.
- Following these best practices for construction will ensure the successful installation of Anchor™ products.



Drainpipe

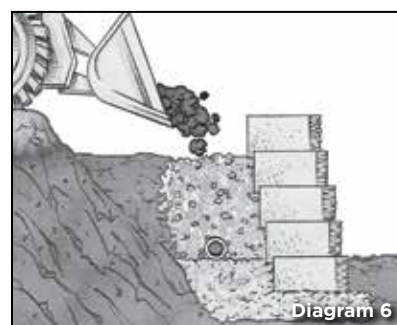

Drainage aggregate

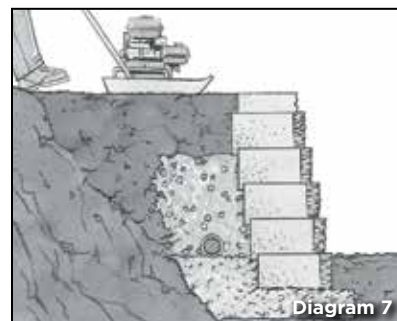

Compaction

*SAFETY NOTE: Always use appropriate equipment, including safety glasses or goggles and respirators, when splitting, cutting or hammering units.*

# Wall Patterns for Multipiece Retaining Wall Systems

## WHEN TO USE A PATTERN

You can install the multipiece retaining wall system in a random pattern using any combination of units. Just avoid vertical lines that span more than 1 foot in height. If you are building a wall without geosynthetic reinforcement, use a pattern for inspiration or follow a pattern exactly. Pleasing random patterns can be built using an equal number of 6- and 3-inch-high blocks or using an equal square footage

of blocks in each size. These patterns are based on using an equal number of blocks of each size in each height.

When building a wall that includes geosynthetic reinforcement, using a pattern at the appropriate spacing eliminates the need to cut the geogrid. When using a pattern, begin at one edge laying the blocks as indicated. Install at least one repeat of the pattern to establish the pattern before proceeding to the next course.

## SEQUENT™ PANEL INSTALLATION PATTERN

### 9-inch by 3-foot installation pattern

This 9-inch-high by 3-foot-long installation pattern uses an equal number of units of each face size to make a panel. This installation pattern is one of many possible options. Others can be used for different appearances.

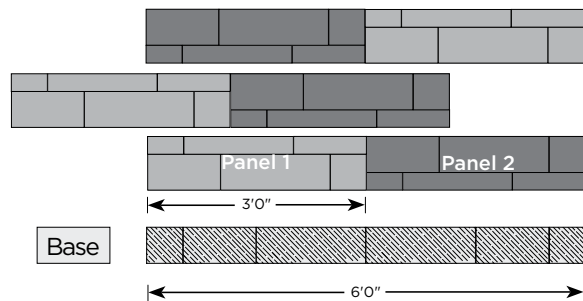

## RANDOM-LOOK INSTALLATION PATTERNS

### 24-inch by 9-foot installation pattern

This illustrates a 24-inch-high by 9-foot-long repeating installation pattern. The installation pattern uses an equal number of units of each face size. When your plan requires geogrid, this installation pattern is ideal because it eliminates cutting if the geogrid is at 24 inches.

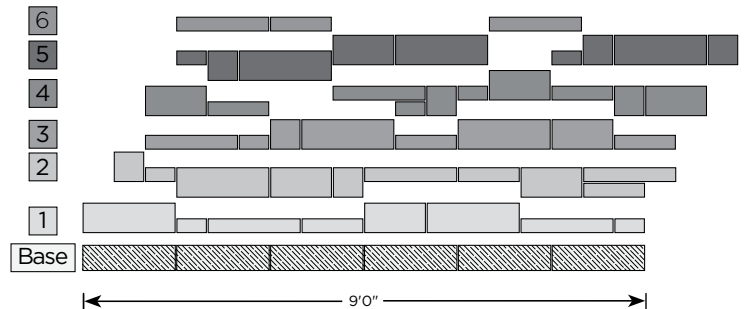

### 18-inch by 6-foot installation pattern

This illustrates an 18-inch-high by 6-foot-long repeating installation pattern. The installation pattern uses an equal number of units of each face size. When your plan requires geogrid, this installation pattern is ideal because it eliminates cutting if the geogrid is at 18 inches.

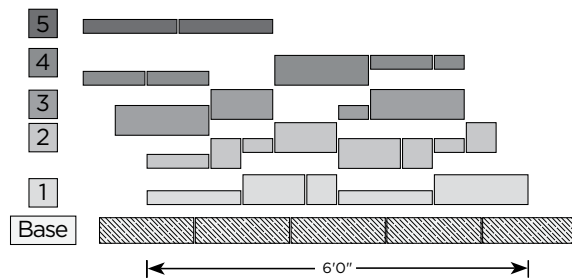

### 12-inch by 9-foot installation pattern

This illustrates a 12-inch-high by 9-foot-long repeating installation pattern. The installation pattern uses an equal number of units of each face size. When your plan requires geogrid, this installation pattern is ideal because it eliminates cutting if the geogrid is at 12 inches.

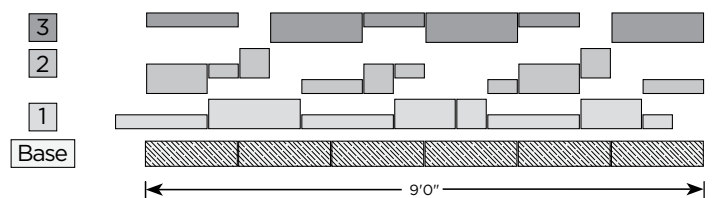



## XL™ CAP STRAIGHT WALL

The XL™ cap must be laid alternately, short and long faces, for a straight line. Always start capping from the lowest elevation. Once caps are aligned, caps should be glued in place using a concrete adhesive.

## CURVES\*

Lay out the cap units side by side with same face facing out (long faces for outside curves; short faces for inside curves). If there's a need to adjust for project's radius, make cuts at least every other cap as needed for the most pleasing aesthetic.

- Minimum radius with XL™ cap: 2'2"

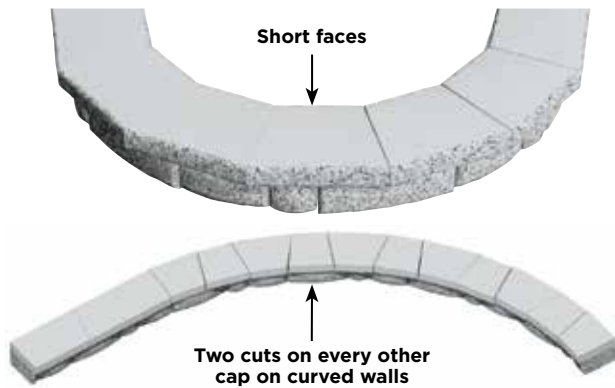

## 90-DEGREE CORNERS

Saw-cut two caps to achieve a 45-degree mitered corner.

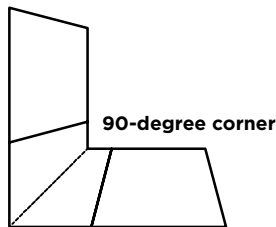

## SHORTCUT CAP STRAIGHT WALL

The ShortCut® cap must be laid alternately, narrow (N) and (W) wide faces, for a straight line. Always start capping from the lowest elevation.

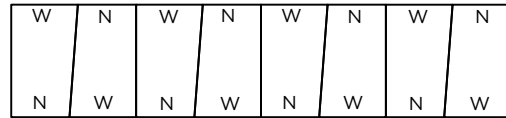

## CURVES

Lay out the cap units side by side with same face facing out (wide faces for outside curves; narrow faces for inside curves). Occasional cutting of some pieces may be necessary.

- Minimum radius with ShortCut® cap: 7'6"

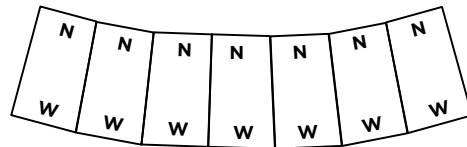

## 90-DEGREE CORNERS

Place two caps together. Measure 1½ inches from corners as shown. Use a straightedge to connect measurements and draw a line. Carefully cut along the line to preserve both sides of the cut. Flip pieces "C" and "D" over to create corner.

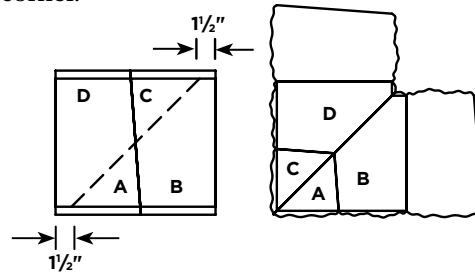

## XL™ CAP OR SHORTCUT® CAP STEPPING UP CAPS

If the wall elevation changes, caps can be stacked where the wall steps up. Begin laying caps at the lowest elevation change and work your way toward the next step up. Split\* a cap unit to fit. Place the split unit directly on top of the capped portion of the wall with all three split faces exposed.

## FINISHING

After layout is complete and caps are saw-cut or split to size, carefully place concrete adhesive on wall top course and then place caps.



\* Use of the ShortCut® cap minimizes cutting.

\*\* To split a block, use a hydraulic splitter or split manually by using a hammer and chisel to score the block on all sides. Pound the chisel on the same line until the block splits. If partial unit sides are not exposed, use a circular cut-off saw with a masonry blade to achieve a tighter fit.

# Stepping Up the Base, Abutting an Existing Structure and Capping a Column

## STEPPING UP THE BASE

### LOWEST POINT

Walls built on a sloping grade require a stepped base. Begin excavation at the lowest point and dig a level trench into the slope until it is deep enough to accommodate the base material and one entire block.

### STEP-UP

At this point, step up the height of one block and begin a new section of base trench. Continue to step-up as needed to top of slope. Always bury at least one full unit at each step.

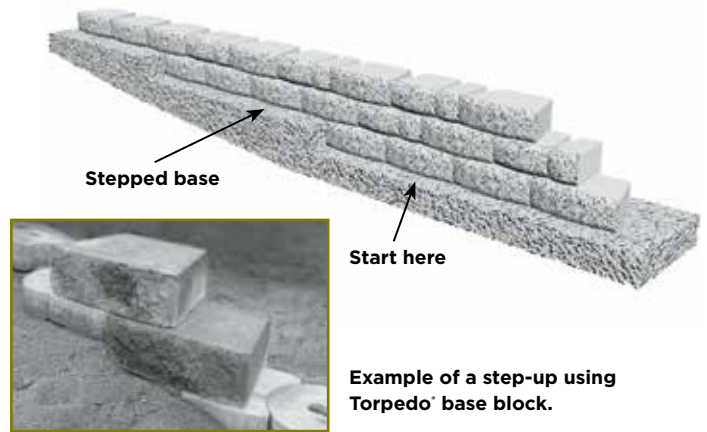

## ABUTTING AN EXISTING STRUCTURE

### FIRST COURSE

Begin with the first block next to the wall and place the first course. Place filter fabric behind the first two large units and extend it 2 feet along the existing structure.

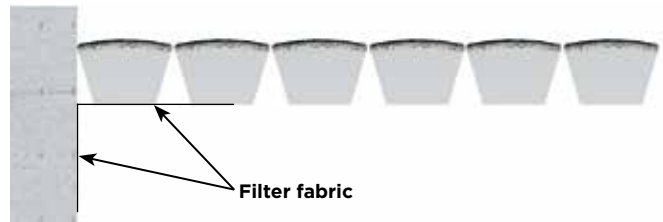

### SECOND COURSE

Build the second course with standard installation techniques. A split unit is shown, but may not be necessary in every installation. Extend filter fabric to the top edge of the final course. A rubber membrane may be placed between the units and a non-concrete wall to prevent moisture damage to the structure.

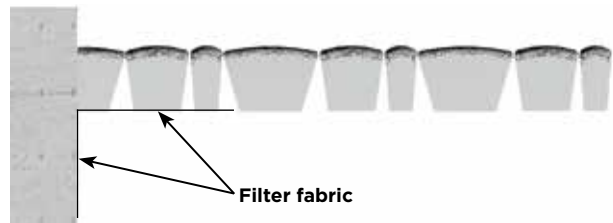

## CAPPING A COLUMN

There are numerous ways to cap a column. You can use the Anchor™ column cap, cap units, single-piece units or natural stone.

Using an XL™ cap—This capping treatment requires eight XL cap units. Each unit is cut as shown. Top with the 5-inch square coupon. Use concrete adhesive to glue all pieces when cap is complete.

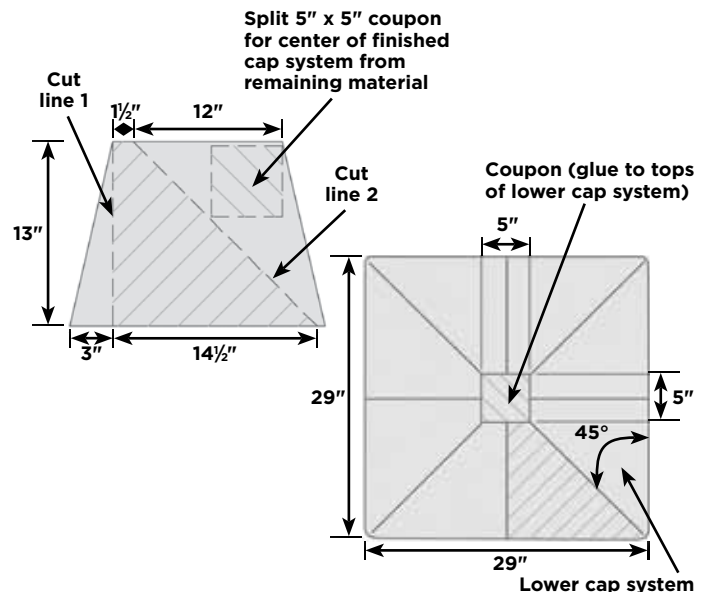

\*\* To split a block, use a hydraulic splitter or split manually by using a hammer and chisel to score the block on all sides. Pound the chisel on the same line until the block splits. If partial unit sides are not exposed, use a circular cut-off saw with a masonry blade to achieve a tighter fit.

## DAYLIGHTING DRAINAGE

### FIRST COURSE

To daylight drainpipes through a wall face, put them on compacted leveling pad aggregate placed behind the first course. Space these drains not more than 50 feet apart. Split 2 inches off the front of two adjacent large units to provide space for the drainpipe to exit through the face.

### SUBSEQUENT COURSES

Build this and remaining courses using standard construction techniques.

*Tip: To daylight through slope, see Drainage Swales.*

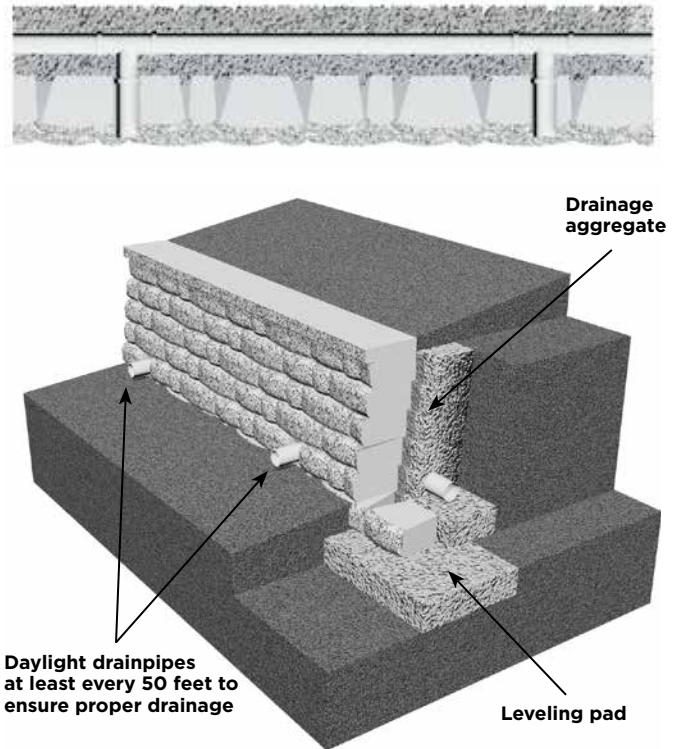

## DRAINAGE SWALES

Design and performance of most retaining walls are based on keeping the reinforced zone relatively dry. Appropriate drainage swales to help control water should be designed into the wall construction plan.

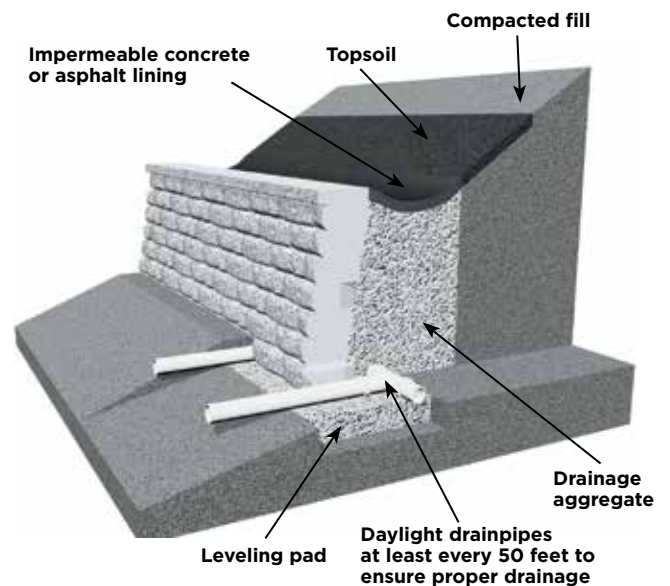
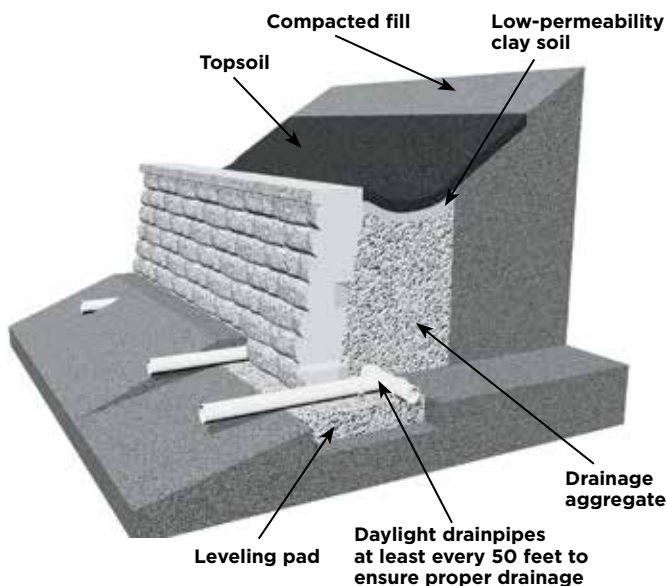

These drawings feature step units. Caps or pavers may be used for treads. Check local building codes for any tread depth standards.

## BASE COURSE

Thoroughly compact the leveling pad. Lay out the base course according to the wall design. Place step units first, working from the center to each side. It is very important to backfill and compact behind and along the sides of each course of step units.

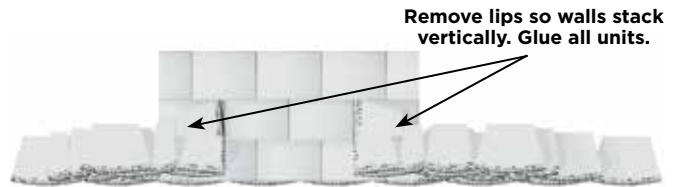

## FIRST STEP COURSE

Place the first course of step units directly on top of the base course so there is no setback. Stagger them from the previous course and glue in place.



## SECOND STEP COURSE

Add the second course of steps, staggering them over the previous course to maintain running bond. Overlap the previous course by 2 inches and glue to the lower course. Place and compact soil fill prior to installing the next course.

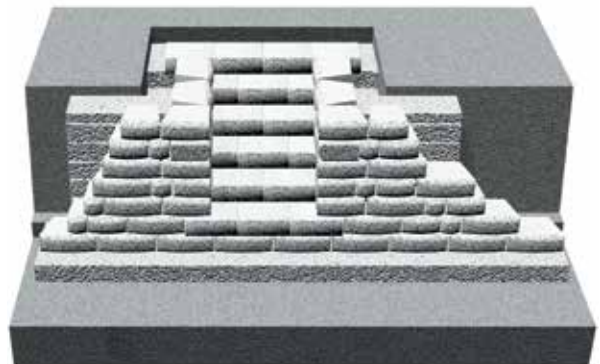

## SECOND WALL COURSE

Build the second course of the wall.

## THIRD STEP COURSE

Beginning in the center, add the third course of steps, lining up the units with the first course. Overlap 2 inches and glue in place.

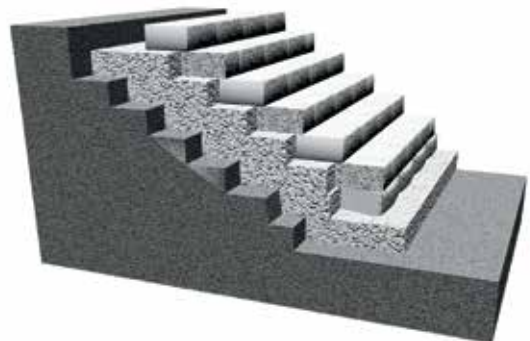

## ADDITIONAL COURSES

Build the third course of the wall. Repeat wall and step courses until the wall is finished.

*Drainage tip: Drainpipe can be placed behind the lowest step units at grade or behind each wall adjacent to the steps.*

These drawings feature step units. Caps or pavers may be used for treads. Check local building codes for any tread depth standards.

## BASE COURSE

Thoroughly compact the leveling pad. Lay out the base course according to the wall design. Place step units first, working from the center to each side. It is very important to backfill and compact behind and along the sides of each course of step units.

## FIRST STEP COURSE

Place the first course of step units directly on top of the base course so there is no setback. Stagger them from the previous course and glue in place.

## SECOND STEP COURSE

Add the second course of steps, staggering them from the previous course to maintain running bond. Overlap the previous course by 2 inches and glue to the lower course. Place and compact soil fill prior to installing the next course.

## SECOND WALL COURSE

Place a block near the second course of steps, maintaining running bond with the base course. Measure and cut a block to fit the space remaining between the step unit and the next course of the wall. Place the unit in the wall, making sure that both vertical edges fit tightly against both the step and standard unit. Remove the rear lip on the blocks when necessary, and angle the blocks flush with the face of the previous course. Glue in place with a concrete adhesive.

## ADDITIONAL COURSES

Beginning in the center, add the third course of steps, lining up the units with the first course. Overlap 2 inches and glue in place. Repeat step and wall courses until the wall is finished.

*Drainage tip: Drainpipe can be placed behind the lowest step units at grade or behind each wall adjacent to the steps.*

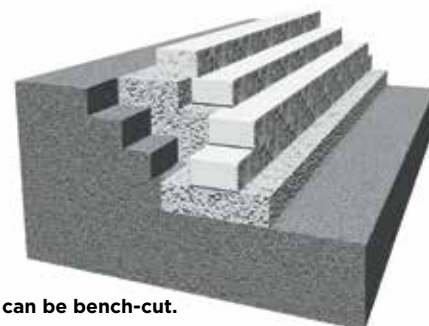
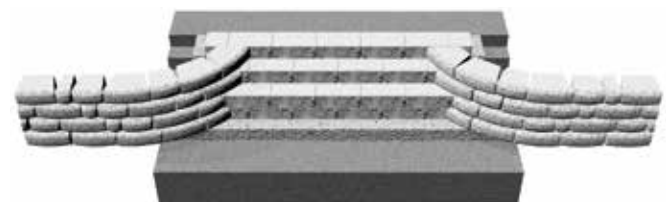
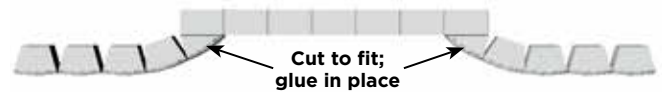

The step can be bench-cut.

## CALCULATE THE RADIUS

When building an outside curve, begin by calculating the radius of the top course. This will be the smallest radius in the wall and must not be less than the minimum radius for the block system used.

To calculate the approximate radius of the top course: Add  $\frac{1}{4}$  inch to the setback of the block used. Multiply that amount by the number of courses in the finished wall. Then subtract the result from the radius of the base course. This number equals the calculated radius of the top course.

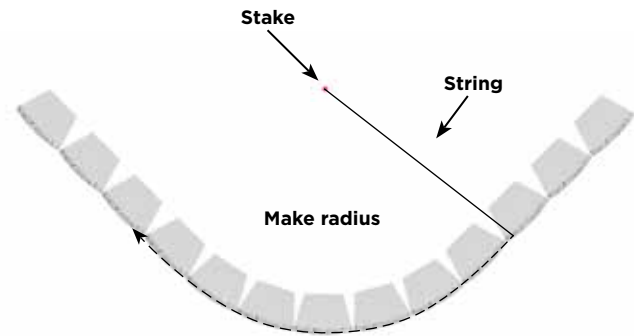

## BASE COURSE

Drive a stake into the ground at the desired center of the curve. Attach a string and rotate it in a circle around the stake to mark the radius in the soil. Align the back of the block with the curve and ensure level placement from side to side and front to back.

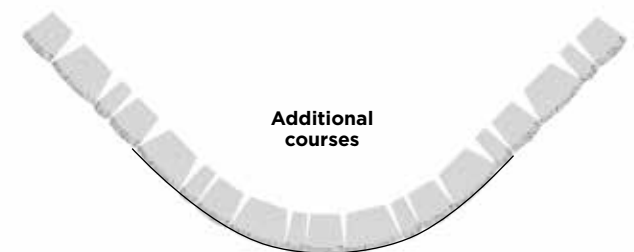

## ADDITIONAL COURSES

On each course, the lip of each block must be in contact with the back of the units below to ensure structural stability. The setback of the block will cause the radius of each course to gradually decrease and eventually affect the running bond of the wall. To maintain proper running bond, use partial units as needed. Once a block is cut to size, glue it in place with a concrete adhesive.



Curving lines add grace and style to any project. See page 8 for information about capping a curve.

# Outside Curves with Geosynthetic Reinforcement

Most retaining walls are designed assuming 100 percent coverage of the geogrid. When building an outside curve, the block edges of the geogrid will have gaps so that the back edges don't overlap. In order to ensure 100 percent coverage, additional lengths of geogrid are used to fill those gaps on the next course of blocks. To prevent slippage, don't overlap the geogrid on any given course.

## FIRST COURSE WITH GEOSYNTHETIC REINFORCEMENT

Cut geogrid to the lengths specified in the wall plan. Lay sections of the geogrid within 1 inch of the face of the wall with the strength direction perpendicular to the wall face. Avoid overlapping the geogrid by separating each section.

## SUBSEQUENT COURSES

Place the next course of blocks, marking their backs to identify unreinforced areas. This step is important because when this course is backfilled, it's impossible to locate the unreinforced areas. Use the marked blocks as a guide, placing subsequent sections of geogrid to overlap the gaps left on the previous course. This will ensure total geogrid coverage. Repeat this procedure throughout the construction of the curve when geogrid is required.

**Cut geogrid to provide as much coverage as possible without overlapping.**

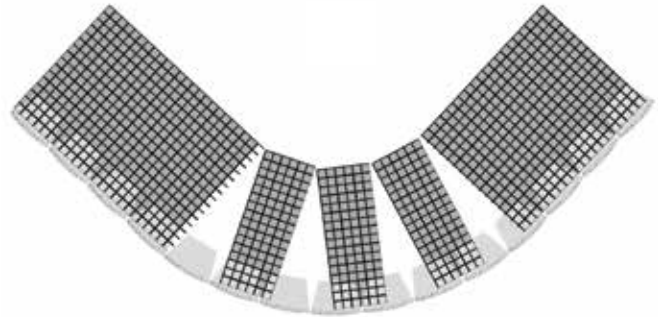

**On the second level, fill in the gaps in the first level with strips of geogrid.**



**From this viewpoint, it is possible to see the complete geogrid coverage between the two layers of geogrid.**

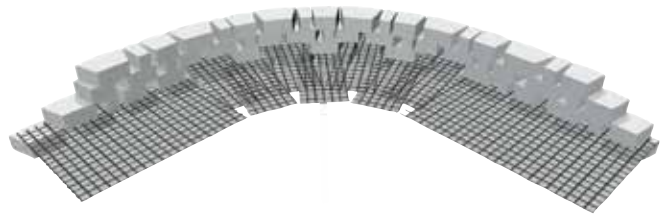

**Turn an open patio into a cozy corner with curved retaining walls. Wall curves are repeated in the steps.**

# Inside Curves and Geosynthetic Reinforcement

## CALCULATE THE RADIUS

Check the wall plan to determine the radius of the base course. This will be the smallest radius in the wall and must not be less than the minimum for the block system used.

## BASE COURSE

Begin by driving a stake into the ground at the desired center of the curve. Attach a string and rotate it in a circle around the stake to mark the radius in the soil. Align each block face with the radius curve and ensure level placement from side to side and front to back.

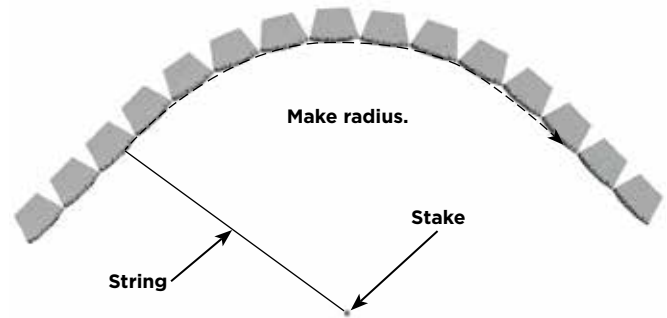

## ADDITIONAL COURSES

On each course, the lip of each block must be in contact with the back of the units below to ensure structural stability. The setback of the block will cause the radius of each course to gradually increase and eventually affect the running bond of the wall. To maintain proper running bond, use partial units as needed. Once a split unit is cut to size, glue in place with a concrete adhesive.



Most retaining walls are designed assuming 100 percent coverage of the geogrid. When building an inside curve, the back edges of the geogrid will fan out, producing slight gaps. In order to ensure 100 percent coverage, additional lengths of geogrid are used to fill those gaps on the next course of blocks. To prevent slippage, don't overlap the geogrid on any given course.

## FIRST COURSE WITH GEOSYNTHETIC REINFORCEMENT

Cut geogrid to the lengths specified in the wall plan. Lay segments of geogrid within 1 inch of the face of the wall, making sure that the strength direction of each section is perpendicular to the wall face. Avoid overlapping the geogrid by separating each section.

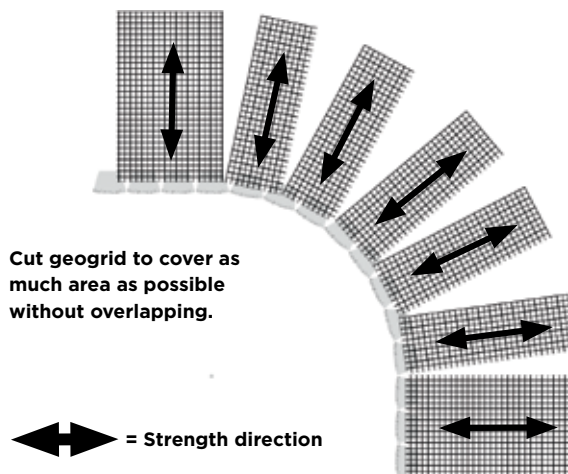

## SUBSEQUENT COURSES

Place the next course of blocks, marking their backs to identify unreinforced areas. This step is important because when this course is backfilled, it's impossible to locate the unreinforced areas. Use the marked blocks as a guide, placing subsequent sections of geogrid to overlap the gaps left on the previous course. This will ensure total geogrid coverage. Repeat this procedure throughout the construction of the curve when geogrid is required.

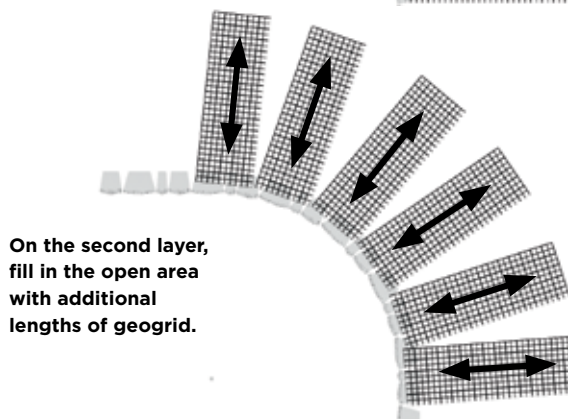



# Outside 90° Corners and Outside Curves with Geosynthetic Reinforcement

## BASE COURSE

To build an outside 90° corner, begin by splitting\* a large block in half. Place this block with both split faces outward at the corner. Remove the rear lip so that the block lies flat. Then lay the rest of the base course working from the corner block out.

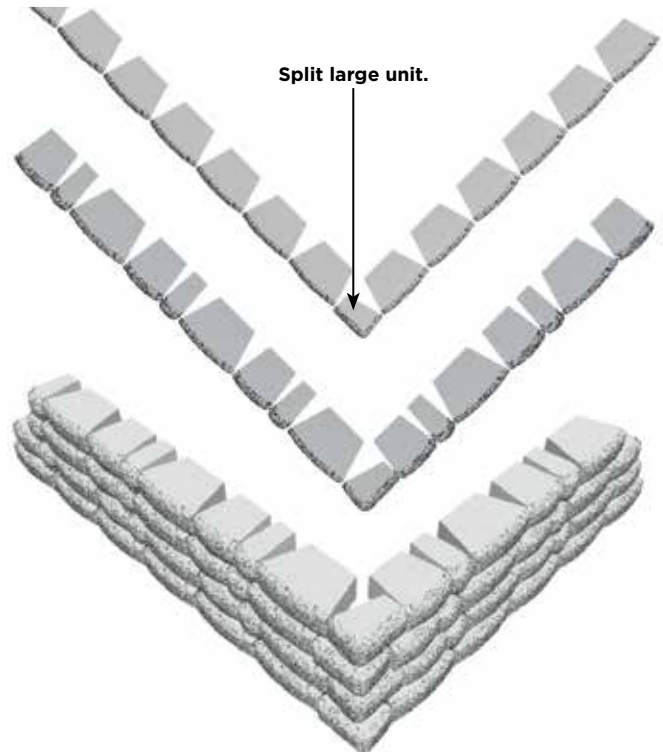

## ADDITIONAL COURSES

Begin the second course with the other half of the large block. Place the second and third blocks on either side of the corner block. Once the corner block is in position, glue it in place with a concrete adhesive. Continue to alternate the corner block orientation with each course and always use a concrete adhesive.

\* To split a block, use a hydraulic splitter or split manually by using a hammer and chisel to score the block on all sides. Pound the chisel on the same line until the block splits. If partial unit sides are not exposed, use a circular cut-off saw with a masonry blade to achieve a tighter fit.

## FIRST COURSE WITH GEOSYNTHETIC REINFORCEMENT

Begin by checking the wall plan to determine geogrid lengths and elevations. Lay a section of geogrid near the corner of the wall, ensuring that it's placed within 1 inch of the face of the block and running along the back of the adjoining wall.

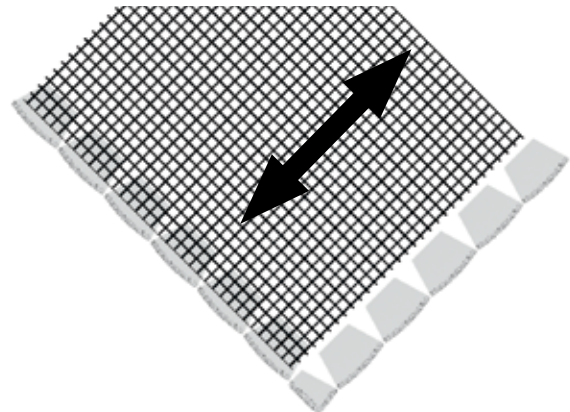

## SUBSEQUENT COURSES

Lay the next course of block, backfill and compact. When installing the next section of geogrid, place within 2 inches of the face of the block and running along the back of the adjacent wall.

There is compacted backfill between geogrid layers.

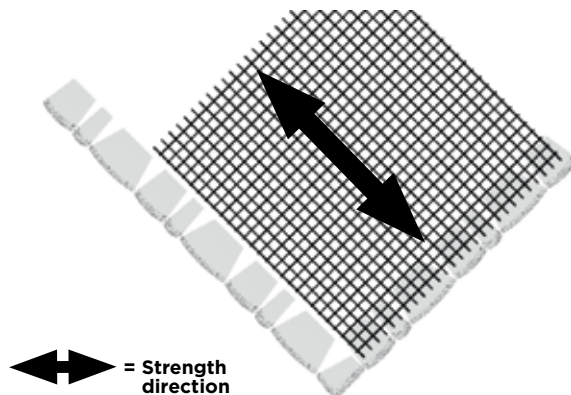
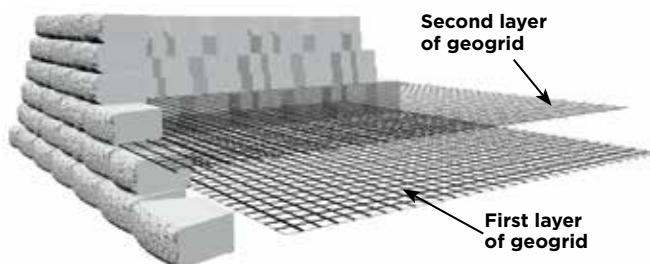

## BASE COURSE

To create an inside 90° corner, begin by placing a block at the corner. Then lay a second block perpendicular to the first and continue laying out the rest of the base course working from the corner out. Remove the rear lip so the block lies flat. Make sure to construct the base course according to standard site prep and installation procedures described earlier.

## ADDITIONAL COURSES

On the second course, place all blocks on bond along one side of the corner. Once the second course of one wall is established, begin the second course of the adjacent wall.

Block placement in the corner should alternate direction with each succeeding course.

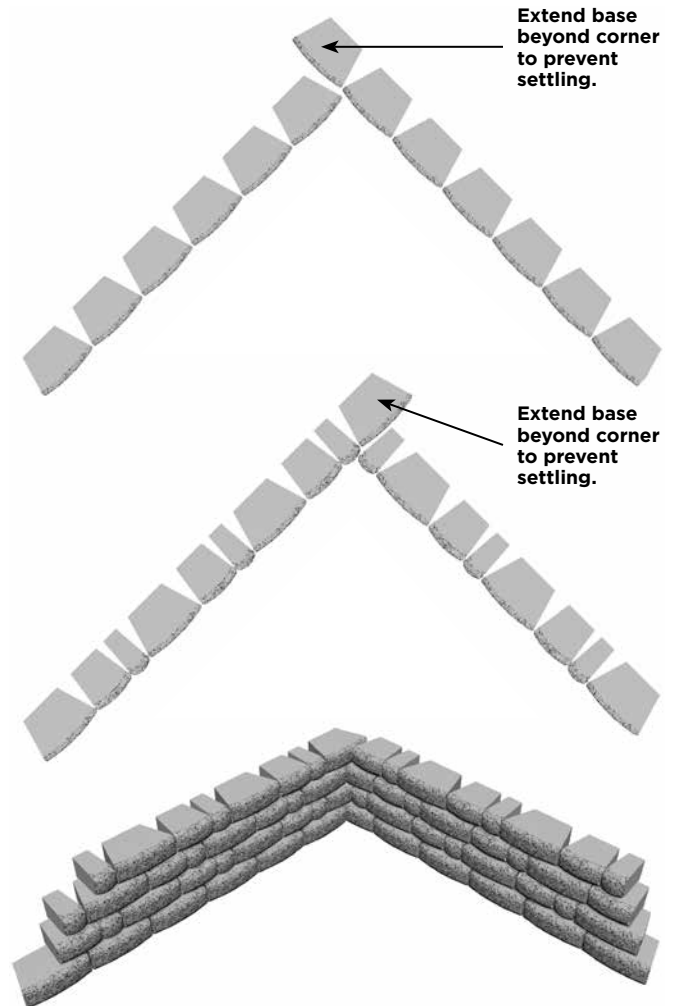

A quiet corner is sheltered with an inside 90° corner built with the Highland Stone® retaining wall system. Step up the caps in 3-inch increments for a finished look.

# Inside 90° Corners with Geosynthetic Reinforcement

## FIRST COURSE WITH GEOSYNTHETIC REINFORCEMENT

Begin by checking the wall plan to determine geogrid lengths and elevations. Cut geogrid to the lengths shown in the wall plan, paying attention to the geogrid strength direction.

Next, determine the proper placement of the geogrid by dividing the proposed height of the wall by four. This represents the distance that geogrid should extend beyond the front of the adjoining wall. Measure this distance from the front of the adjoining wall, and begin the geogrid placement here. Make sure the geogrid is placed within 1 inch of the face of the wall and runs along the back of the adjoining wall.

*Example: If overall wall height is 8 feet, the geosynthetic reinforcement extension would be 2 feet.*

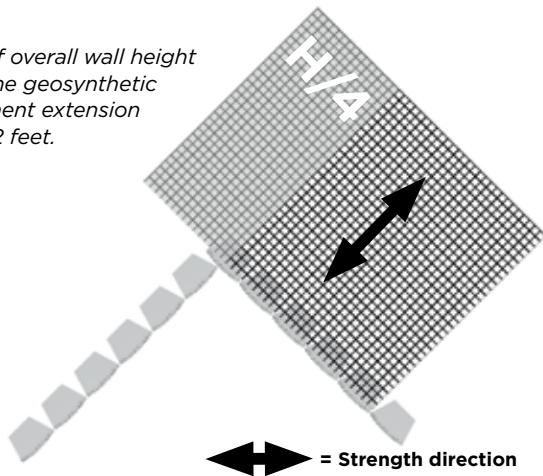

Place the next section of geogrid on the adjoining wall. The geogrid should not overlap and should lie flush with previously placed sections. Once geogrid is in place, the next courses of block can be installed.

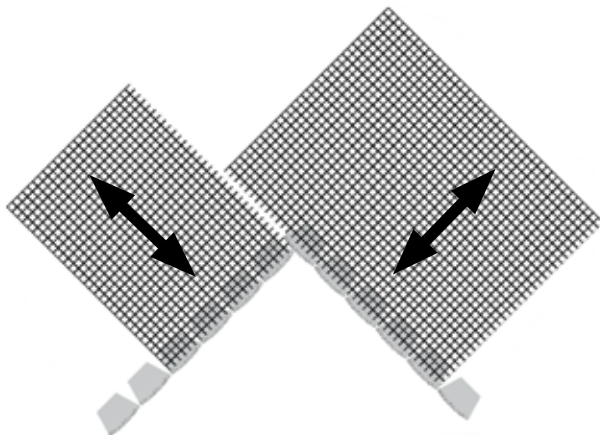

## SUBSEQUENT COURSES

The first section of grid on these courses is placed using the same formula that determines placement in front of the adjoining wall.

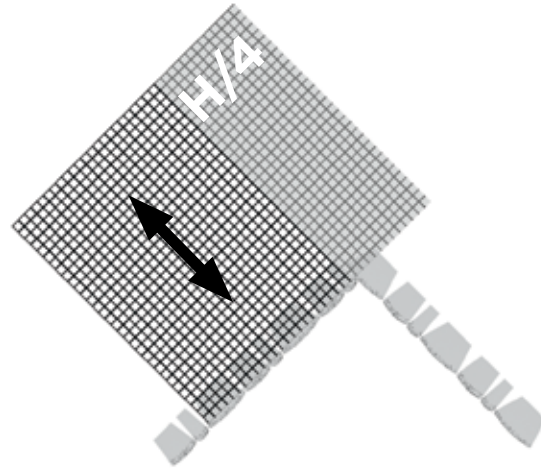

Alternate the geosynthetic reinforcement extension on each course where geogrid is required.

Place the next section of geogrid on the adjoining wall. The geogrid should not overlap and should lie flush with previously placed sections. Once geogrid is in place, the next courses of block can be installed.

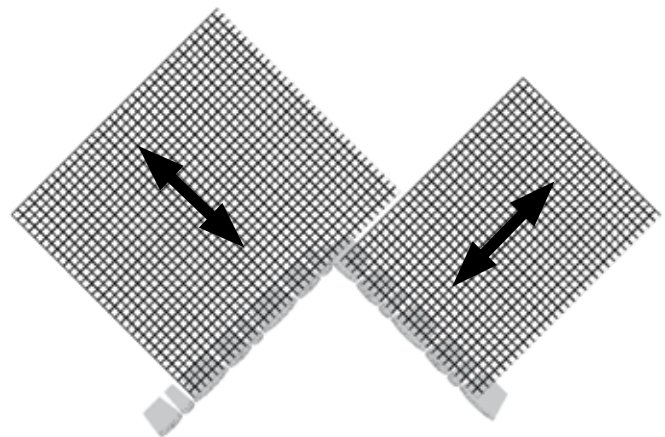

With correct design and construction, Anchor™ products can be successfully installed at the edge of water channels, river banks and drainage ditches.

The final design of the wall is affected by various factors, including the movement and velocity of the adjacent water, erosion and scour, the direction of water travel to the wall, the risk of flooding, as well as the soil and ground conditions where the wall is being built.

A qualified engineer should always be consulted to determine the effect of water on the wall and to design a wall that takes all these factors into account.

Consult a qualified engineer before design, construction and installation take place, and follow the engineer's design.

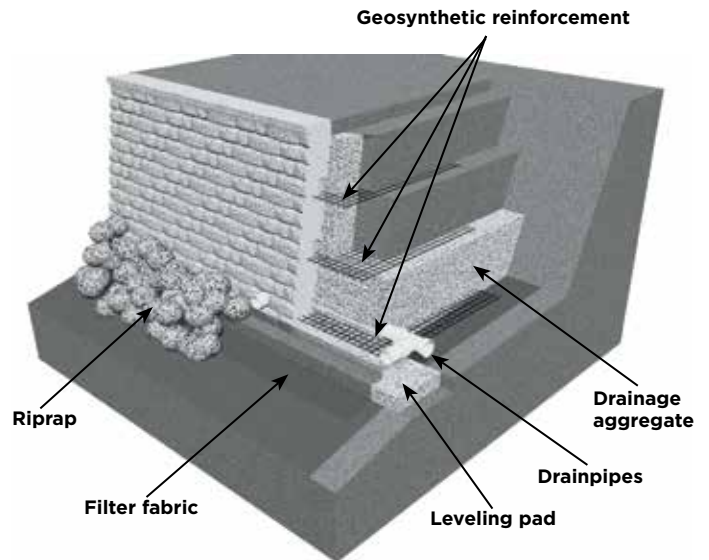

## BASE COURSE

Place a filter fabric with extra length in front of the wall.

Install the leveling pad and the base course of block, including drain tile and drainage aggregate. Wrap the extended filter fabric up along the face of the base course. Place soil fill in front of the wall and compact. Install another section of filter fabric in front of the wall to protect against erosion. Cover the fabric with a minimum of 3 inches of sand. Install larger stones, such as riprap, to hold it in place.

## NEXT COURSE

Continue constructing the wall. Drainage is vital. To prevent clogging of the drainage aggregate and drainpipe by fine-grained soils, a filter fabric is installed to separate the drainage aggregate from the reinforced soils.

## ADDITIONAL COURSES

Continue these steps until the wall is complete. The last section of filter fabric should cover the drainage aggregate and run up against the back of the top course of block. Add fill soil and compact.



Water applications are a great way to get more use from a property.

## INDEPENDENT TERRACED WALLS

For each wall to be independent of others, it must be built using a 2:1 ratio – the upper wall must be built a distance away from the lower wall of at least twice the height of the lower wall. In addition, the upper wall must also be equal to or less than the height of the lower wall. Exceptions to this general rule include weak soil conditions or where slopes exist above, below or between wall locations. For example, if the lower terrace is 4 feet tall, the distance between the terraces must be at least 8 feet and the upper wall must not be higher than 4 feet.

Drainage is vital to maintaining stable, long-lasting terraced walls. Drainpipe must be installed so that the water is directed around or under the lower wall (never place the drain outlet for the upper wall above or behind the lower wall).

*For more detailed information about drainage, see Daylighting and Drainage Swales on page 9.*

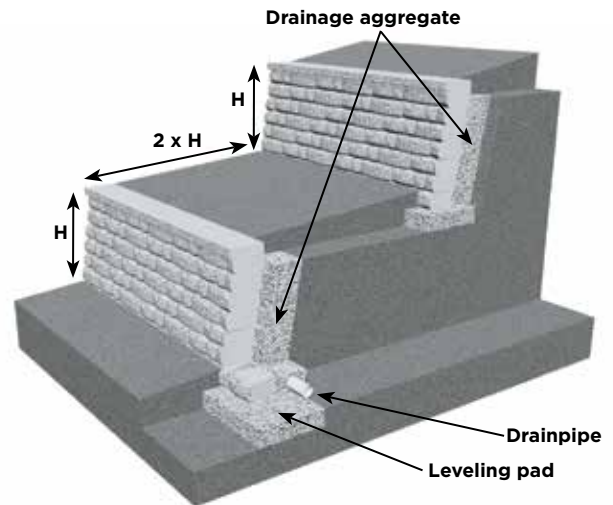

## DEPENDENT TERRACED WALLS

When the distance between the lower and upper walls is less than twice the height of the lower wall, the walls become structurally dependent on each other. In this situation, it is important to take global stability into account, incorporating additional geogrid- and longer layers – into the wall plan. In addition, structurally dependent walls require even more excavation, backfill and time. So plan ahead. Be sure to check the wall plan for specific requirements. For structurally dependent walls, consult with a qualified engineer.

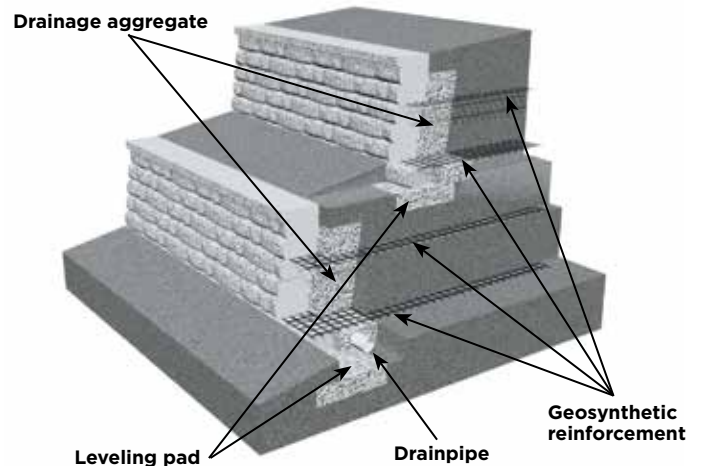

## FENCES

Know the dimensions of the fence to determine the placement of the sleeves. Provide at least 1 inch clearance between the inside of the sleeve and the outside of the post, and allow for mortar and grout. Install the sleeves according to the wall plan during the construction of the wall.

If the fence is at least 3 feet behind the wall, generally no additional geogrid is required. If the fence is installed within 3 feet, there may be some load transferred to the wall from wind, snow or pedestrians. Additional geogrid around the fence sleeves may be needed.

Grout the fence post into the sleeve after the wall is built.

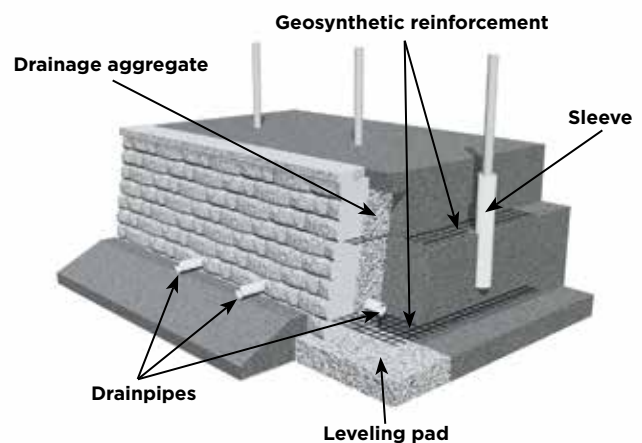

# Freestanding Wall Installation Instructions

## PREPARE LEVELING PAD

Excavate for the leveling pad. To accommodate the Torpedo® base block the trench should be 24" wide and 12" deep; otherwise, the trench should be a minimum of 21 inches wide and should be 6 inches deeper than the block. See *Diagram 1*.

Create a leveling pad of compacted base material that extends a minimum of 6 inches in front of and 6 inches behind the wall units. This pad should also be at least 6 inches deep after compaction.

## BASE COURSE\*

Once the pad is compact and level, begin placing the units. Center the units on the pad. The ends of the units should be in contact. The base course must be buried below grade and should be included when calculating total wall height. See *Diagram 2*.



### Base course

*It's easiest to build the base course for a straight wall out of large freestanding wall units.*

*\*The Torpedo® base block is an option for Anchor™ freestanding walls instead of the large freestanding wall units.*

## BUILDING THE WALL

Units can be placed in any order to form an aesthetically pleasing layout. The simplest is one that incorporates large, medium and small units. The units should be installed so the ends are in complete contact with each other. Remember to keep the wall on bond by placing units in a staggered relationship to the course beneath. Repeat this process to complete the wall. Glue the top two courses and caps in place with a concrete adhesive.



### Next course

## ENDING A WALL

Split a large unit into pieces sized as needed. Do not use pieces smaller than 6 inches wide. If needed, cut the second-to-last piece and make the last piece the appropriate size. Smaller pieces should be glued into place with a concrete adhesive. After splitting the end piece, use a hammer and chisel to create a rounded appearance to match the manufactured split blocks.



### Wall end

Split

## CAPPING A COLUMN AND A WALL

See pages 7 and 8 for details about cap installation.

## INSTALLATION PATTERN

### 6" Multipiece Freestanding Wall System Installation Pattern

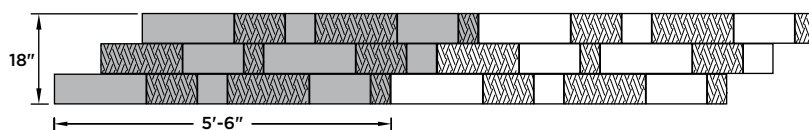

 Pattern indicates the shorter side of the block.

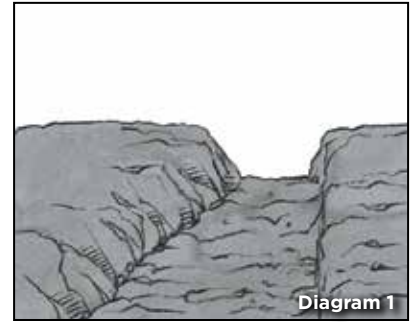

Diagram 1

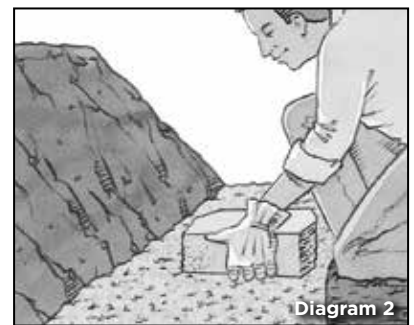

Diagram 2

# Freestanding Wall Installation Instructions

## STRUCTURAL DESIGN ELEMENTS

Structural design elements must be used if a freestanding wall is more than 10 feet long. Structural design elements include

- curved walls
- freestanding wall jog
- 90° corner
- columns

## CURVED WALLS

Add stability and a natural flow to walls with curves. While units can be turned somewhat, it may be necessary to make cuts with a concrete saw or splitter. As a rule, the smaller the units, the tighter the radius. Conversely, the larger the units, the larger the radius. Use approximately the same number of units for each course. The approximate minimum radius the system can turn, using all three pieces without cutting, is 3.75 feet measured to the outside face of the wall.

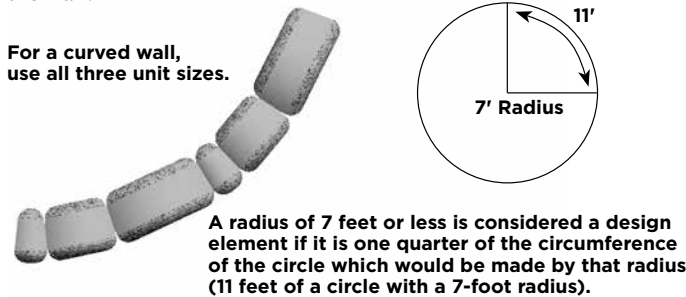

## 90° CORNER

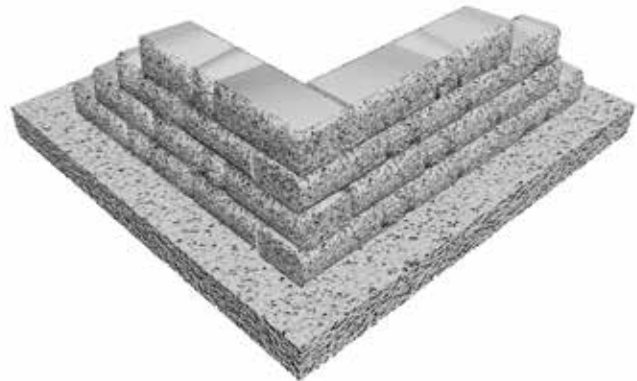

To create a 90° corner in a straight wall, make a third side to a large unit by splitting it to the appropriate dimension. Use only large units to assure connecting units are on bond. Alternate the direction the units face with each course. Round the split ends with a hammer and chisel. Glue all corner courses with a

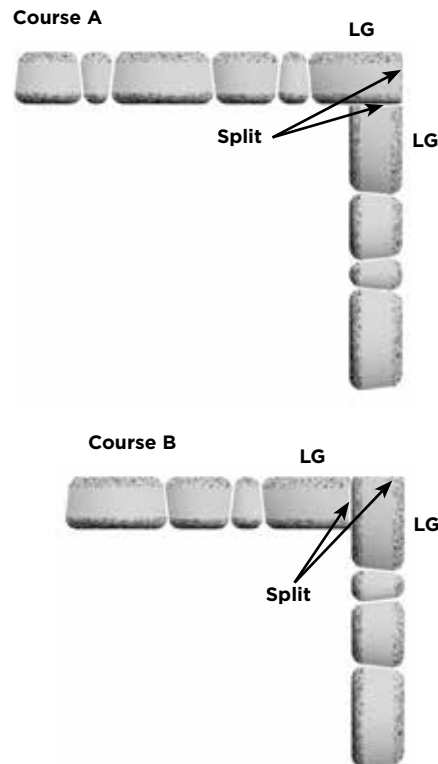

concrete adh  
Reference  
LG = large unit  
MD = medium unit

## FREESTANDING WALL JOG



Jogs are used to break up straight lines and add stability to walls. Split units as needed. Use hammer and chisel to round split faces. Glue all courses of jog with a concrete adhesive.

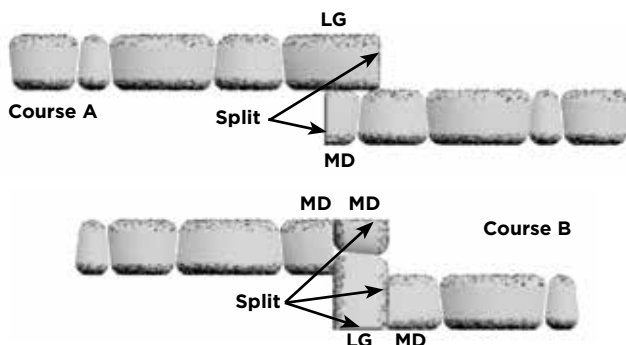

# Construction Details for Multipiece Freestanding Wall Systems

## COLUMNS

When used with a freestanding wall, a column increases wall stability. Placing fixtures on columns is also a great way to incorporate lighting. Columns can be located in the middle or at the end of a wall. The open space in the center of a column permits reinforcement or electrical wiring if needed. The column leveling pad should extend 6 inches beyond each column edge and be at least 6 inches deep after compaction.

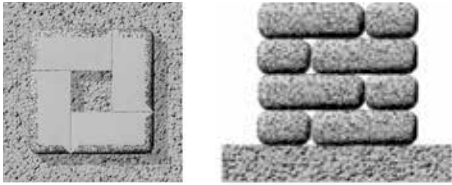

## COLUMN AT END OF WALL—CENTERED



To build columns at the end of a wall, cut one column unit in half for the second, fourth and additional even-numbered courses. Stack column units in a rotating pattern for each course so that the bond is staggered. One column unit half is used every two courses. Glue each course of column units with a concrete adhesive. Integrate wall into column as shown to increase stability.

## CAPPING A COLUMN AND A WALL

See pages 7 and 8 for details about cap installation.

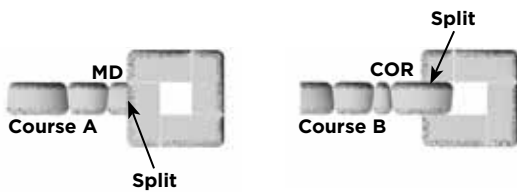

*Reference*  
 COR = corner/column unit  
 LG = large unit  
 MD = medium unit

## COLUMN AT END OF WALL—OFFSET

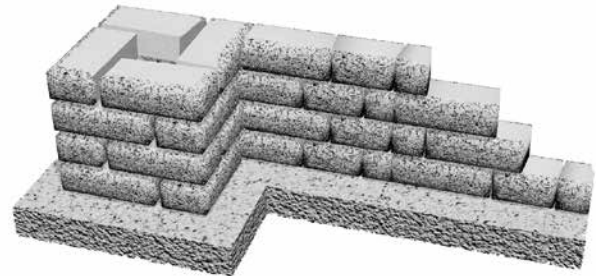

To build a column at the end of a wall, stack three column units as shown for the base course. For the second course, use column units, stacking in a rotating pattern. Glue each course of units in the column with concrete adhesive.

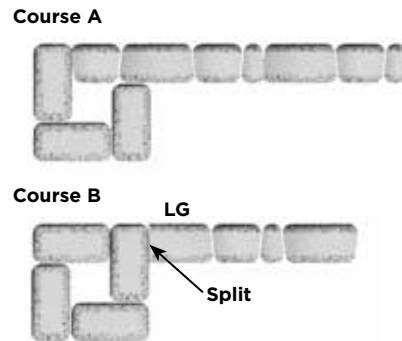

## WALL THROUGH COLUMN



On the first course, use complete column units to start the column and cut the wall units to fit. On the second course, cut two column units in half to fill in the corners. Continue construction by alternating courses. Glue all column courses with a concrete adhesive.

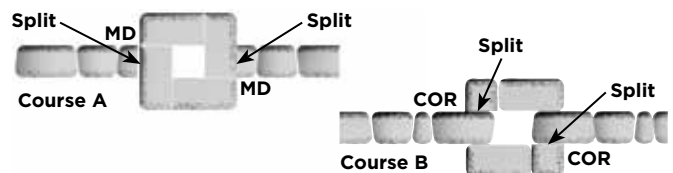



# Construction Details for Multipiece Freestanding Wall Systems

## COLUMN IN RUNNING WALL



Columns add stability and elegance to a wall. They are located on one side of a wall. To build a column, stack column units in a rotating pattern for each course. Cut wall units as indicated. Glue each course of units in the column with a concrete adhesive.

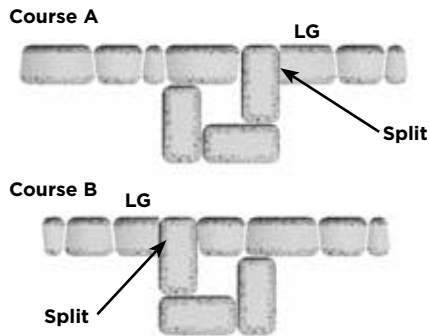

## SMALL COLUMN IN WALL



There are times when a column of a different size is needed. To build a smaller column in the running wall, you will need to split a medium stretcher unit for the first course. Split it so that the pieces, combined with another medium unit, equal 18 inches. Place the units parallel to the wall on the prepared leveling pad. For the second course, split a large stretcher unit and a medium stretcher unit so that they equal 18 inches. Split a second set of large and medium units to make a second 18-inch section. Insert these units perpendicular to the wall as shown. Glue all courses. Round the split ends with a hammer and chisel.

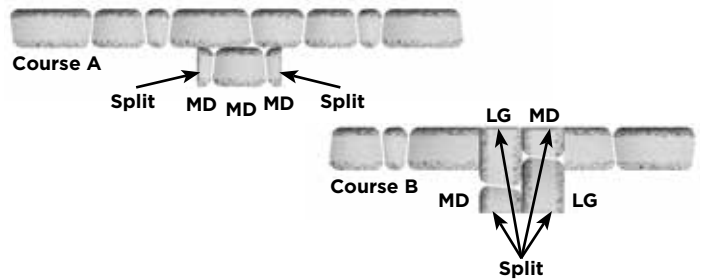

## 90° CORNER AT COLUMN



Frequently, a 90° turn is made at a column. To build this column, cut one column unit per course. Stack column units in a rotating pattern for each course. Glue each course of column units with a concrete adhesive.

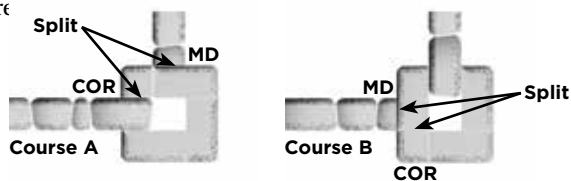

## SMALL COLUMN AT END OF WALL

To build a small column at the end of a running freestanding wall, you will need to split four stretcher units for the first course. Split a large and a medium unit so they equal 18 inches. Split a second set of units to make a second 18-inch section. Insert these units perpendicular to the wall as shown.



For the second course, center a medium stretcher unit over the base units as shown. Split another unit to maintain a staggered bond. Round the split ends with a hammer and chisel. Glue all units in the column with a concrete adhesive.

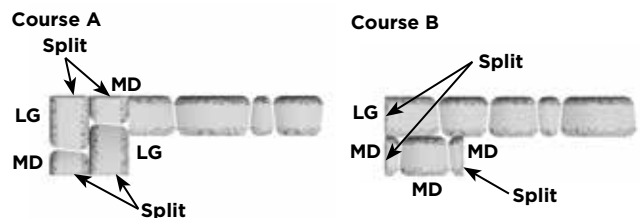

# Multipiece Wall Systems

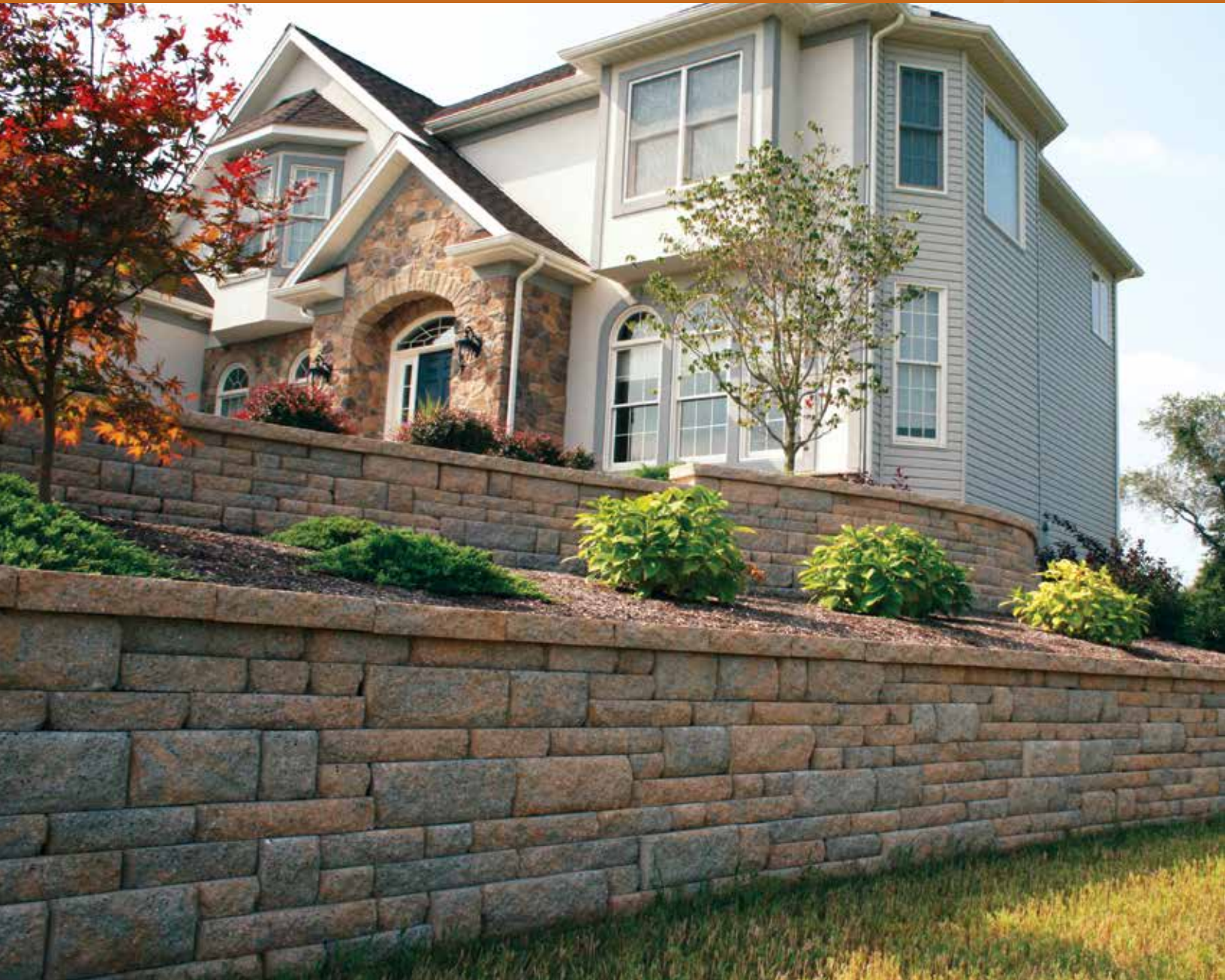

©2015 Anchor Wall Systems, Inc. The logos, slogans, product names and other trademarks depicted herein are trademarks of Anchor Wall Systems (AWS). These wall systems and products are covered by the AWS Limited Warranty. For a complete copy, visit your local dealer or see [anchorwall.com](http://anchorwall.com).

Anchor Wall Systems, Inc., 5959 Baker Road, Suite 390, Minnetonka, MN 55345.

72.3288.4 05/15 4012



# LOCATIONS & CONTACT INFO

## ASP ENTERPRISES

aspent.com  
salesasp@aspent.com

## BOWMAN CONSTRUCTION SUPPLY

bowmanconstructionsupply.com  
salesbcs@bowmanconstructionsupply.com

## QUICK SUPPLY CO.

quicksupplyco.com  
salesquick@quicksupplyco.com

## CASCADE GEOSYNTHETICS

cascadageos.com  
salescascade@cascadageos.com

**St. Louis, MO** 636.343.4357  
**Omaha, NE** 402.861.8579  
**Kansas City, MO** 816.554.1191  
**Wichita, KS** 316.393.1554

**Denver, CO** 303.696.8960  
**Colorado Springs, CO** 719.257.7840  
**Loveland, CO** 970.535.0863

**Des Moines, IA**  
515.289.1271

**Portland, OR**  
971.339.1020

# SOLUTIONS WE SUPPLY

## GEOSYNTHETICS

Filter Fabrics  
Stabilization Fabrics

### Geogrids

- Road Grids
- Wall Grids
- Slope Stabilization

### Specialty Fabrics

#### Composite Geomembranes

- GCLs, PVC, HDPE, LLDPE, EPDM, Granular Bentonite

## SEDIMENT CONTROL

### Inlet Protection

- Grated Inlet, Curb Inlet, Area Inlet Protection

### Ditch Checks

- Triangle Silt Dike
- GeoRidge

### Perimeter Protection

- High and Low-Porosity Silt Fence, Straw Wattles, Silt Socks
- Safety Fence

### Flocculants & Water Treatment

- Polymer-Based & Natural Flocculants

### Sediment Basin Skimmers

### Dewatering Bags

### Trackout Control

- FODS
- Rumble Grates

### Turbidity Curtains

## EROSION CONTROL

### Basic Hydraulically Applied Mulches

- Wood
- Paper
- Blends
- Straw

### High-Performance Hydraulically Applied Products

- BFM
- FGM
- Additives & Tackifiers

### Temporary Erosion Control Blankets

- Coir & Jute Mat/Nettings
- Short-Term ECBs
- Extended-Term ECBs

### Permanent Erosion Control Blankets

- Turf Reinforcement Mats
- HP-TRMs
- Anchor Reinforced Vegetation System

### Structural BMPs

- Transition Mats
- Geoweb Cellular Confinement
- Composite Vegetated Armor System
- Flex MSE Vegetated Wall System
- Articulated Concrete Block
- Gabions
- Grout-Filled Geotextile Mats

### Vegetation Establishment

- Native Seed & Turf Seed
- Fertilizers
- Organic Soil Additives
- Stratavault Soil Cells

## STORMWATER MANAGEMENT

### Water Quality

- Inlet Filter Boxes
- Pre-Treatment Chamber
- Nutrient Separating Baffle Boxes
- High-Flow Biofiltration Media
- Hydrodynamic Separators
- Stratavault

### Water Quantity

- Modular Underground Storage Systems
- Chamber Detention Systems

### Drainage

- HDPE Swale Liner
- Pipe & Fittings
- Drainage Composites
- Strip Drain

### Inlet Structures

- PVC
- Drain Basins, In-Line Drains
- Landscape

### Permeable Pavers

- Permeable Articulating Concrete Block
- Grass Pavers
- Gravel Pavers
- Concrete Pavers

## SPECIALTY

### Natural & Synthetic Coir Fiber Logs

### Vegetated Reinforced Soil Slopes

### Soil Anchors

### Root Barrier System

### AquaBlok

### Muscle Wall

We are full line distributors of construction materials for all project types. Contact us for assistance with a project. From specification and development to installation and completion, we're here to help with all of your site solution needs.

**GEOSYNTHETICS | EROSION CONTROL | STORMWATER MANAGEMENT  
SEDIMENT CONTROL | REVEGETATION | HARDSCAPES**